

**Kramer Electronics, Ltd.**

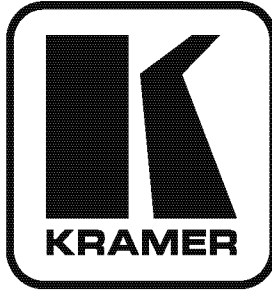

# **USER MANUAL**

**Models:**

***TP-145, XGA / Audio / Data Line Transmitter***

***TP-146, UXGA / Audio / Data Line Receiver***

## Contents

<b>1</b>	<b>Introduction</b>	<b>1</b>
<b>2</b>	<b>Getting Started</b>	<b>1</b>
2.1	Quick Start	2
<b>3</b>	<b>Overview</b>	<b>2</b>
3.1	Shielded Twisted Pair/Unshielded Twisted Pair	3
3.2	Defining the EDID	3
3.3	Recommendations for Achieving the Best Performance	4
<b>4</b>	<b>Defining the TP-145/TP-146</b>	<b>4</b>
4.1	Defining the TP-145 XGA/Audio/Data Line Transmitter	4
4.2	Defining the TP-146 UXGA/Audio/Data Line Receiver	5
4.2.1	Internal Polarity and Sync Mode Switches	7
<b>5</b>	<b>Connecting the TP-145 and the TP-146</b>	<b>7</b>
5.1	Transmitting via RS-232	9
5.2	Wiring the Twisted Pair RJ-45 Connectors	9
<b>6</b>	<b>Acquiring the EDID</b>	<b>10</b>
<b>7</b>	<b>Technical Specifications</b>	<b>11</b>

## Figures

Figure 1: TP-145 XGA/Audio/Data Line Transmitter Front and Rear Panels	5
Figure 2: TP-146 UXGA/Audio/Data Line Receiver Front and Rear Panels	6
Figure 3: TP-146 Internal Polarity Switches	7
Figure 4: Connecting the UXGA/Audio/Data Line Transmitter/Receiver System	8
Figure 5: RS-232 Pinout Connection	9
Figure 6: TP Connector	10

## Tables

Table 1: TP-145 XGA/Audio/Data Line Transmitter Front and Rear Panel Features	5
Table 2: TP-146 UXGA/Audio/Data Line Receiver Front and Rear Panel Features	6
Table 3: TP-146 Internal Polarity Switches and Descriptions	7
Table 4: RS-232 Pinout Connection	9
Table 5: TP Connector Pinout	10
Table 6: Technical Specifications of the TP-145 and TP-146	11

## 1 Introduction

Welcome to Kramer Electronics! Since 1981, Kramer Electronics has been providing a world of unique, creative, and affordable solutions to the vast range of problems that confront the video, audio, presentation, and broadcasting professional on a daily basis. In recent years, we have redesigned and upgraded most of our line, making the best even better! Our 1,000-plus different models now appear in 11 groups<sup>1</sup> that are clearly defined by function.

Thank you for purchasing the Kramer TOOLS **TP-145 XGA/Audio/Data Line Transmitter**<sup>2</sup>, and/or **TP-146 UXGA/Audio/Data Line Receiver** which are ideal for:

- Presentation and multimedia applications
- Long range graphics distribution for schools, hospitals, security, and stores

Each package includes the following items:

- **TP-145** or **TP-146**
- Power adapter (12V DC output)
- This user manual<sup>3</sup>

This user manual describes the following Kramer TOOLS™:

- **TP-145 XGA/Audio/Data Line Transmitter** (see [Section 4.1](#))
- **TP-146 UXGA/Audio/Data Line Receiver** (see [Section 4.2](#))

## 2 Getting Started

We recommend that you:

- Unpack the equipment carefully and save the original box and packaging materials for possible future shipment
- Review the contents of this user manual
- Use Kramer high-performance high-resolution cables<sup>4</sup>

---

1 GROUP 1: Distribution Amplifiers; GROUP 2: Switchers and Matrix Switchers; GROUP 3: Control Systems; GROUP 4: Format/Standards Converters; GROUP 5: Range Extenders and Repeaters; GROUP 6: Specialty AV Products; GROUP 7: Scan Converters and Sealers; GROUP 8: Cables and Connectors; GROUP 9: Room Connectivity; GROUP 10: Accessories and Rack Adapters; GROUP 11: Sierra Products

2 Up to WUXGA resolution 1920 x 1200

3 Download up-to-date Kramer user manuals from <http://www.kramerelectronics.com>

4 The complete list of Kramer cables can be found at <http://www.kramerelectronics.com>

## 2.1 Quick Start

This quick start chart summarizes the basic setup and operation steps.

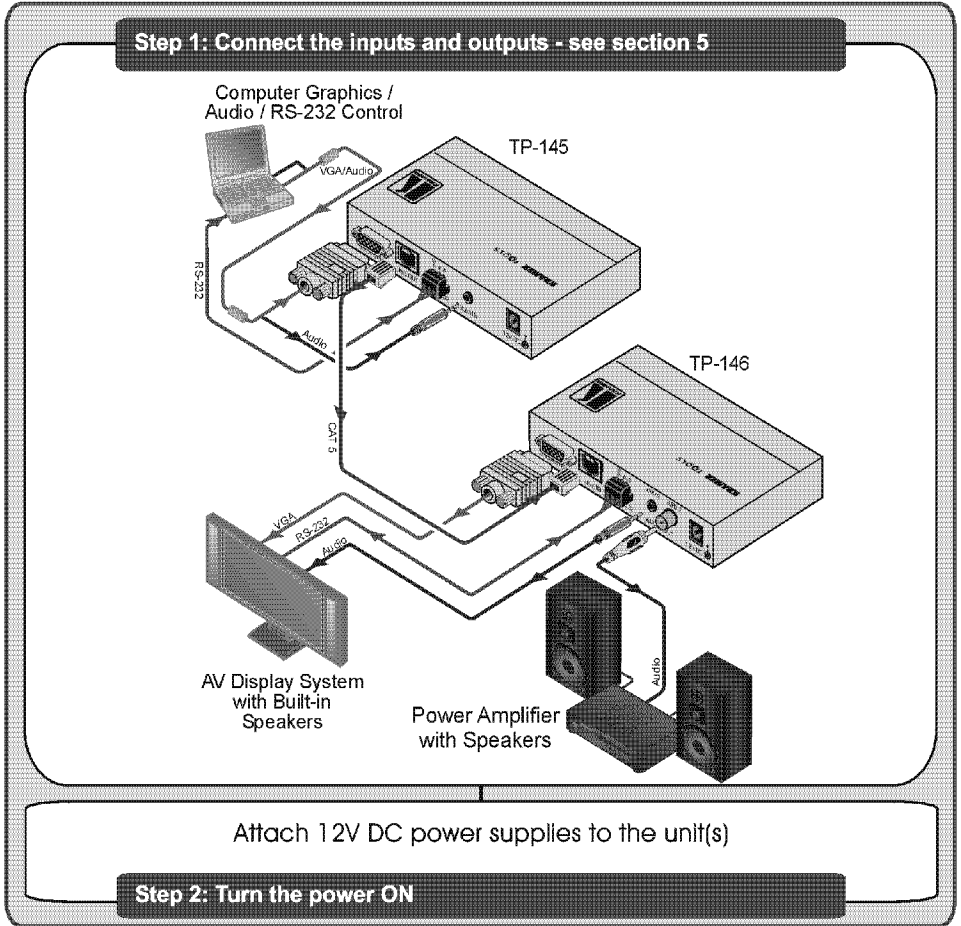

## 3 Overview

The **TP-145** and **TP-146** are high-performance, Twisted Pair (TP) transmitter and receivers for computer graphics video (including HDTV), unbalanced stereo audio, and RS-232 control commands.

The **TP-145** converts computer graphics video, unbalanced stereo analog audio, and RS-232 control commands to a TP signal. The **TP-146** converts the TP signal back into computer graphics video, unbalanced stereo and S/PDIF digital audio,

and RS-232 control signals. The **TP-145** and **TP-146** together form a computer graphics/audio/control data line transmitter/receiver system.

More specifically, the products feature:

- Resolution up to WUXGA 1920 x 1200
- HDTV compatibility
- EDID capture and status indication (**TP-145**)
- Simultaneous unbalanced stereo and S/PDIF (24-bit 48kHz) audio outputs (**TP-146**)
- Level (gain) and EQ (peaking) controls (**TP-146**)
- Full duplex RS-232 transmission
- Increased level of protection against noise, spikes, and interference in adverse environments
- System range up to 200m (656ft)

### 3.1 Shielded Twisted Pair/Unshielded Twisted Pair

We recommend that you use Shielded Twisted Pair (STP) cable. There are different categories of STP cable available and we advise you to use the best quality STP cable that you can afford. Our non-skew-free cable, Kramer **BC-STP** is intended for digital signals and for analog signals where skewing is not an issue. For cases where there is skewing, our Unshielded Twisted Pair (UTP) skew-free cable, Kramer **BC-XTP**, may be used. Bear in mind though, that we advise using STP cables where possible, since the compliance to electromagnetic interference has been tested using STP cables.

Although UTP cable might be preferred for long range applications, the UTP cable should be installed as far as possible from electric cables, motors, and so on, which often create electrical interference.

However, since the use of UTP cable might cause non-conformity to electromagnetic standards, Kramer does not commit to meeting the standard with UTP cable.

### 3.2 Defining the EDID

EDID (Extended Display Identification Data<sup>1</sup>) is a data-structure that the display provides to describe its capabilities to a graphics card connected to the display's source. The EDID enables the source, such as a PC, to "know" what kind of monitor is connected to the output.

The EDID includes information, such as, the name of the manufacturer, product type, timing data supported by the display, display size, luminance data, and (for digital displays only) the pixel mapping data.

---

<sup>1</sup> EDID is defined by a standard published by the Video Electronics Standards Association (VESA)

The **TP-145** can store and recall EDID data in non-volatile memory, allowing convenient and reliable connection to the source.

### 3.3 Recommendations for Achieving the Best Performance

To achieve the best performance:

- Use only good quality connection cables<sup>1</sup> to avoid interference, deterioration in signal quality due to poor matching, and elevated noise levels (often associated with low-quality cables)
- Avoid interference from neighboring electrical appliances that may adversely influence signal quality, and position your Kramer **TP-145/TP-146** away from moisture, excessive sunlight and dust

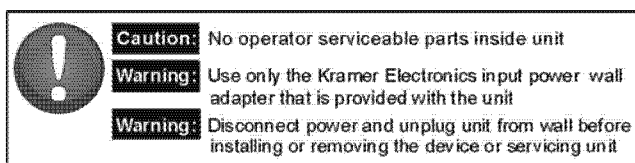

## 4 Defining the TP-145/TP-146

This section defines the:

- **TP-145**, *XGA/Audio/Data Line Transmitter* (see [Section 4.1](#))
- **TP-146**, *UXGA/Audio/Data Line Receiver* (see [Section 4.2](#))

### 4.1 Defining the TP-145 XGA/Audio/Data Line Transmitter

The **TP-145** is a high-performance transmitter that accepts:

- A computer graphics input signal
- An unbalanced stereo analog audio signal
- RS-232 control commands

The **TP-145** encodes the signals and transmits them over TP cable to a **TP-146** receiver. The stereo analog audio signal is converted to a digital audio (S/PDIF) stream before transmission, thus preserving the quality of the audio source signals. Commands and data can flow in both directions simultaneously via the RS-232 interface, allowing status requests and control of the destination unit.

When the **TP-145** is connected to a display device and the EDID CAPTURE button is pressed, the **TP-145** reads and stores the EDID (Extended Display Identification Data) from the display device. This prevents the problem whereby a

---

<sup>1</sup> Available from <http://www.kramerelectronics.com>

source (for example, a PC), fails to output video because it was not connected to the display device when attempting to read its EDID.

Figure 1 and Table 1 define the TP-145.

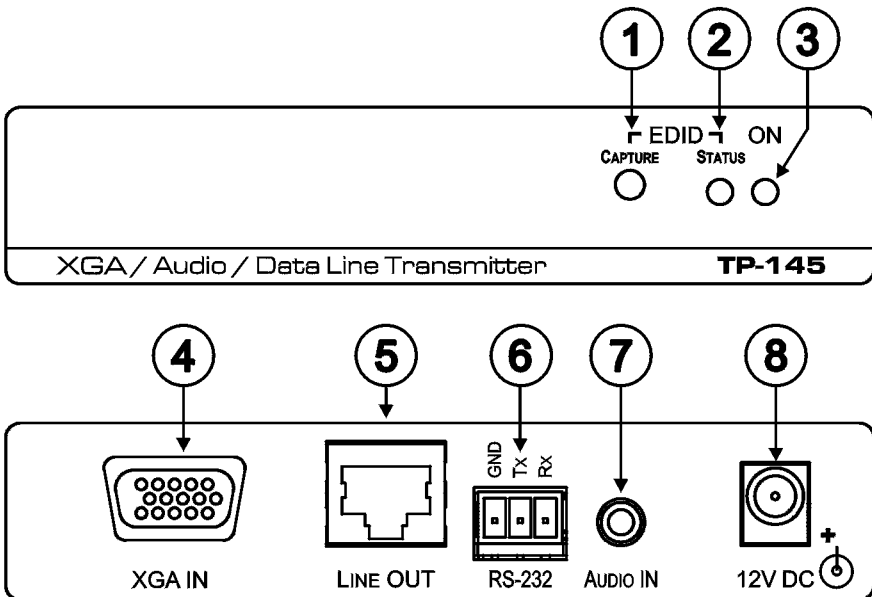

Figure 1: TP-145 XGA/Audio/Data Line Transmitter Front and Rear Panels

Table 1: TP-145 XGA/Audio/Data Line Transmitter Front and Rear Panel Features

#	Feature	Function
1	EDID CAPTURE Button	Press to capture the EDID
2	EDID STATUS LED	Lights Green when the EDID has been successfully captured
3	ON LED	Lights Green when the unit receives power
4	XGA IN 15-pin HD (F) Connector	Connect to the UXGA source
5	LINE OUT RJ-45 Connector	Connect to the LINE IN RJ-45 connector on the TP-146
6	RS-232 Terminal Block	Connect to the PC or the Remote Controller (see Section 5.1)
7	AUDIO IN 3.5mm Mini Connector	Connect to the analog audio source
8	12V DC Power Connector	Connect to the supplied +12V DC power adapter. Center conductor positive

## 4.2 Defining the TP-146 UXGA/Audio/Data Line Receiver

The TP-146 is a high-performance receiver that accepts the computer graphics signal/audio/control data from the Kramer TP-145 via TP cabling at its RJ-45 LINE IN input. The TP-146 outputs a computer graphics signal, an unbalanced stereo analog audio signal, a converted digital audio (S/PDIF) signal, and bi-directional RS-232 control commands and data. The RS-232 interface makes it possible to control virtually any device over a transmission range of up to 200m

(660ft) with a Kramer **TP-141/145** transmitter over TP cabling. In addition, the **TP-146** features:

- Level and Equalization control for the UXGA signal
- The capability to change the polarity of the vertical and horizontal sync signals
- 24 bit 48kHz S/PDIF digital audio

Figure 2 and Table 2 define the **TP-146** UXGA/Audio/Data Line Receiver.

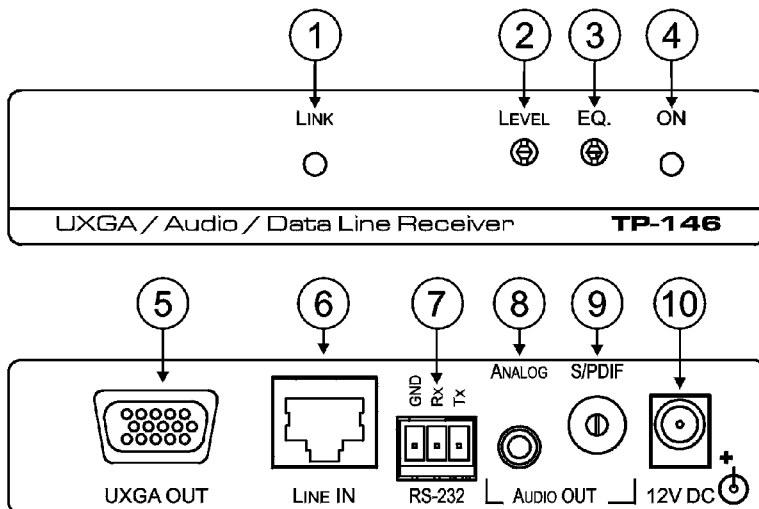

Figure 2: TP-146 UXGA/Audio/Data Line Receiver Front and Rear Panels

Table 2: TP-146 UXGA/Audio/Data Line Receiver Front and Rear Panel Features

#	Feature	Function	
1	LINK LED	Lights green when a link is established	
2	LEVEL Trimmer	Adjusts the output signal level	
3	EQ <sup>1</sup> Trimmer	Adjusts the cable compensation equalization level	
4	ON LED	Lights green when the unit receives power	
5	UXGA OUT 15-pin HD (F) Connector	Connect to the UXGA acceptor	
6	LINE IN RJ-45 Connector	Connect to the LINE OUT RJ-45 connector <sup>2</sup> on the TP-145	
7	RS-232 Terminal Block	Connect to the controlled unit	
8	AUDIO OUT	ANALOG 3.5mm Mini Connector	Connect to the analog audio acceptor
9		S/PDIF RCA Connector	Connect to the digital audio acceptor
10	12V DC Connector	Connect to the supplied +12V DC power adapter. Center pin positive	

1 Degradation and UXGA signal loss can result from using long cables (due to stray capacitance), sometimes leading to a total loss of sharpness in high-resolution signals

2 Using a TP cable with RJ-45 connectors at both ends (pinout is defined in Figure 6 and Table 5)



#### 4.2.1 Internal Polarity and Sync Mode Switches

Figure 3 and Table 3 define the internal horizontal and vertical polarity switches of the TP-146.

**Note:** You need to open the TP-146 unit to gain access to the Hs and Vs polarity and video selection switches which are located on the lower part of the printed circuit board next to the ON LED. After setting the switches, close the TP-146.

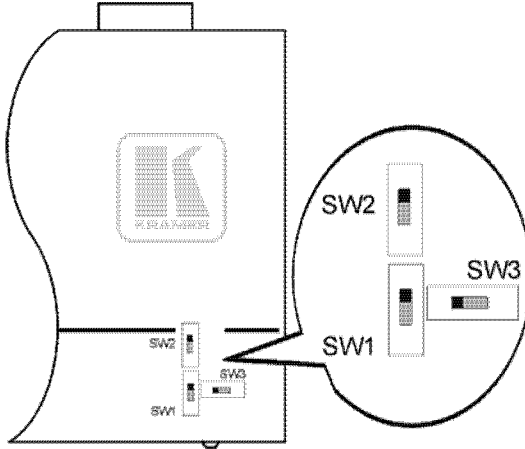

Figure 3: TP-146 Internal Polarity Switches

Table 3: TP-146 Internal Polarity Switches and Descriptions

Switch/Jumper	Function
SW1 Horizontal Sync Switch	Slide up to set the H Sync to positive polarity Slide down to set the H Sync to negative polarity Default = up (positive polarity)
SW2 Vertical Sync Switch	Slide up to set the V Sync to positive polarity Slide down to set the V Sync to negative polarity Default = up (positive polarity)
SW3 Video Selection Switch	Slide left to set the video to RGBHV/VGA Slide right to set the video to Component/Composite video with sync Default = left (RGBHV/VGA video)

## 5 Connecting the TP-145 and the TP-146

You can use the TP-145 *UXGA/Audio/Data Line Transmitter* and the TP-146 *UXGA/Audio/Data Line Receiver* to configure a TP transmitter and receiver system that transmit video, audio, and RS-232 control signals via TP cable.

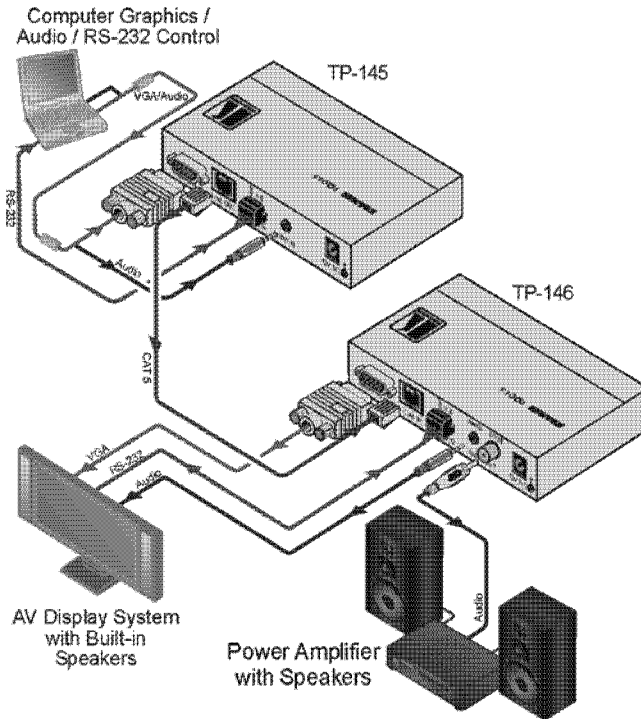

Figure 4: Connecting the UXGA/Audio/Data Line Transmitter/Receiver System

To connect the TP-145 and the TP-146 to create a TP transmitter and receiver system, as illustrated in Figure 4:

1. On the **TP-145**, connect:
  - A UXGA source (for example, the graphics card on a laptop) to the UXGA IN 15-pin HD (F) connector
  - An audio source to the AUDIO IN 3.5mm mini connector, for example, using a Kramer C-GMA/GMA cable (VGA 15-pin HD (M) +Audio jack to VGA 15-pin HD (M) +Audio jack)<sup>1</sup>
  - An RS-232 cable with a 9-pin D-sub connector at one end to the laptop, and a 3 pin terminal block connector at the other end to the **TP-145** RS-232 port<sup>2</sup>
2. On the **TP-146**, connect:
  - The UXGA OUT 15-pin HD (F) connector to the AV display system
  - The S/PDIF AUDIO OUT RCA connector to a digital AV Receiver

<sup>1</sup> Not supplied. The full list of Kramer cables is available from <http://www.kramerelectronics.com>. Alternatively, you can connect a UXGA source to the UXGA IN 15-pin HD (F) connector, and a separate audio source to the AUDIO IN 3.5mm mini connector

<sup>2</sup> As defined in Figure 5 and Table 4

- An RS-232 cable with a 3 pin terminal block connector at one end to the **TP-146** RS-232 port<sup>1</sup>, and a 9-pin D-SUB connector at the other end to the RS-232 port on the AV display system
3. Using STP cabling<sup>2</sup>, connect the LINE OUT RJ-45 connector on the **TP-145** to the LINE IN RJ-45 connector on the **TP-146**.
  4. Connect the power adapter to the power socket on the **TP-145** and/or **TP-146** (if needed), and connect the adapter(s) to the mains electricity.
  5. On the **TP-146**:
    - If necessary, adjust the video output signal level and/or cable compensation equalization level with a flat screwdriver
    - If necessary, set the horizontal sync switches, vertical sync switches, and the sync mode jumpers (see [Section 4.2.1](#))

## 5.1 Transmitting via RS-232

It is possible to transmit data (for example, using a PC) between the **TP-145** and **TP-146** via the RS-232 terminal block.

Prepare an RS-232 cable with a 9-pin D-sub connector at one end, and a 3 pin terminal block at the other end as defined in [Table 4](#) and [Figure 5](#).

Table 4: RS-232 Pinout Connection

Terminal Block	9-pin D-sub Connector
TxD	Pin 2
RxD	Pin 3
GND	Pin 5

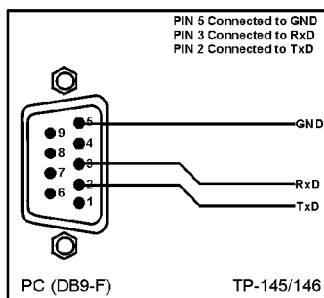

Figure 5: RS-232 Pinout Connection

## 5.2 Wiring the Twisted Pair RJ-45 Connectors

When using STP cable, connect/solder the cable shield to the RJ-45 connector shield. [Table 5](#) and [Figure 6](#) define the TP pinout using a straight pin-to-pin cable with RJ-45 connectors.

<sup>1</sup> As defined in [Figure 5](#) and [Table 4](#)

<sup>2</sup> For details of how to wire a TP RJ-45 connector, see [Section 5.2](#)

Table 5: TP Connector Pinout

EIA /TIA 568A		EIA /TIA 568B	
PIN	Wire Color	PIN	Wire Color
1	Green/White	1	Orange/White
2	Green	2	Orange
3	Orange/White	3	Green/White
4	Blue	4	Blue
5	Blue/White	5	Blue/White
6	Orange	6	Green
7	Brown/White	7	Brown/White
8	Brown	8	Brown
Pair 1 4 and 5		Pair 1 4 and 5	
Pair 2 3 and 6		Pair 2 1 and 2	
Pair 3 1 and 2		Pair 3 3 and 6	
Pair 4 7 and 8		Pair 4 7 and 8	

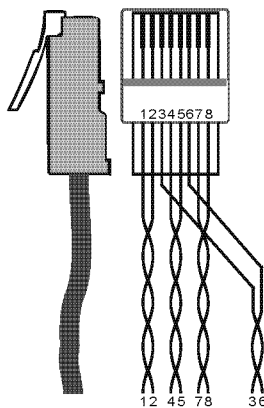

Figure 6: TP Connector

## 6 Acquiring the EDID

The **TP-145** transmitter can capture the EDID information from a display device.

### To load the default EDID:

1. Plug the 12V DC power adapter into the power socket on the **TP-145** and connect the adapter to the mains electricity.
2. With no display device connected to the **TP-145**, press the EDID CAPTURE button.
3. The EDID STATUS LED flashes rapidly several times and the new EDID is copied.

### To capture the EDID information from a display device:

1. Using a short cable<sup>1</sup>, connect the XGA INPUT 15-pin HD connector on the **TP-145** to the input XGA connector of the display.
2. Connect power to the display and switch it on.
3. Plug the 12V DC power adapter into the power socket on the **TP-145** and to the mains electricity.
4. Press the EDID CAPTURE button.
5. The EDID STATUS LED flashes slowly several times and the EDID is captured.
6. Disconnect the display.

<sup>1</sup> For example, Kramer model number C-MGM/MGM-1

## 7 Technical Specifications

Table 6 lists the technical specifications of the **TP-145** and **TP-146**.

*Table 6: Technical Specifications of the TP-145 and TP-146*

	TP-145	TP-146
INPUTS:	Video: 1 XGA on a 15-pin HD connector Audio: 1 Analog 3.5mm mini connector	1 RJ-45 LINE IN connector
OUTPUTS:	1 RJ-45 OUT TP connector	Video: 1 UXGA on a 15-pin HD connector Audio: 1 S/PDIF RCA connector 1 Analog 3.5mm mini connector
PORTS:	1 RS-232 bidirectional terminal block	
RESOLUTION:	Up to WUXGA, 1080p	
MAX. OUTPUT LEVEL:		Video: 1.6V Audio: 2.3V
CONTROLS:	EDID capture button	Level: -7.5dB to +4.4dB, EQ.: 0dB to +33dBm (130m) @ 50MHz
RS-232 BAUD RATE:	Up to 19200kbps	
RS-232 MODE:	Full-duplex	
BANDWIDTH:	Audio: 20Hz – 20kHz @0.5dB	
S/N RATIO:	Audio: <-80dB	
TOTAL GAIN:	Audio: Analog/analog: 0dB Analog/SPDIF: -12dBFS	
COUPLING:	AC	
TND+N:	Audio: <0.01%	
POWER SOURCE:	12V DC 180mA	12V DC 370mA
DIMENSIONS:	12.0cm x 7.8cm x 2.5cm (4.7" x 3.1" x 1.0") W, D, H	
WEIGHT:	0.18kg. (0.4lbs.) approx.	
ACCESSORIES:	Power supply	

---

## LIMITED WARRANTY

Kramer Electronics (hereafter *Kramer*) warrants this product free from defects in material and workmanship under the following terms.

### HOW LONG IS THE WARRANTY

Labor and parts are warranted for seven years from the date of the first customer purchase.

### WHO IS PROTECTED?

Only the first purchase customer may enforce this warranty.

### WHAT IS COVERED AND WHAT IS NOT COVERED

Except as below, this warranty covers all defects in material or workmanship in this product. The following are not covered by the warranty:

1. Any product which is not distributed by Kramer, or which is not purchased from an authorized Kramer dealer. If you are uncertain as to whether a dealer is authorized, please contact Kramer at one of the agents listed in the Web site [www.kramerelectronics.com](http://www.kramerelectronics.com).
2. Any product, on which the serial number has been defaced, modified or removed, or on which the WARRANTY VOID IF TAMPERED sticker has been torn, reattached, removed or otherwise interfered with.
3. Damage, deterioration or malfunction resulting from:
  - i) Accident, misuse, abuse, neglect, fire, water, lightning or other acts of nature
  - ii) Product modification, or failure to follow instructions supplied with the product
  - iii) Repair or attempted repair by anyone not authorized by Kramer
  - iv) Any shipment of the product (claims must be presented to the carrier)
  - v) Removal or installation of the product
  - vi) Any other cause, which does not relate to a product defect
  - vii) Cartons, equipment enclosures, cables or accessories used in conjunction with the product

### WHAT WE WILL PAY FOR AND WHAT WE WILL NOT PAY FOR

We will pay labor and material expenses for covered items. We will not pay for the following:

1. Removal or installations charges.
2. Costs of initial technical adjustments (set-up), including adjustment of user controls or programming. These costs are the responsibility of the Kramer dealer from whom the product was purchased.
3. Shipping charges.

### HOW YOU CAN GET WARRANTY SERVICE

1. To obtain service on your product, you must take or ship it prepaid to any authorized Kramer service center.
2. Whenever warranty service is required, the original dated invoice (or a copy) must be presented as proof of warranty coverage, and should be included in any shipment of the product. Please also include in any mailing a contact name, company, address, and a description of the problem(s).
3. For the name of the nearest Kramer authorized service center, consult your authorized dealer.

### LIMITATION OF IMPLIED WARRANTIES

All implied warranties, including warranties of merchantability and fitness for a particular purpose, are limited in duration to the length of this warranty.

### EXCLUSION OF DAMAGES

The liability of Kramer for any effective products is limited to the repair or replacement of the product at our option. Kramer shall not be liable for:

1. Damage to other property caused by defects in this product, damages based upon inconvenience, loss of use of the product, loss of time, commercial loss; or
2. Any other damages, whether incidental, consequential or otherwise. Some countries may not allow limitations on how long an implied warranty lasts and/or do not allow the exclusion or limitation of incidental or consequential damages, so the above limitations and exclusions may not apply to you.

This warranty gives you specific legal rights, and you may also have other rights, which vary from place to place.

**NOTE:** All products returned to Kramer for service must have prior approval. This may be obtained from your dealer.

This equipment has been tested to determine compliance with the requirements of:

- EN-50081: "Electromagnetic compatibility (EMC);  
generic emission standard.  
Part 1: Residential, commercial and light industry"
- EN-50082: "Electromagnetic compatibility (EMC) generic immunity standard.  
Part 1: Residential, commercial and light industry environment".
- CFR-47: FCC\* Rules and Regulations:  
Part 15: "Radio frequency devices  
Subpart B Unintentional radiators"

### CAUTION!

- ☒ Servicing the machines can only be done by an authorized Kramer technician. Any user who makes changes or modifications to the unit without the expressed approval of the manufacturer will void user authority to operate the equipment.
- ☒ Use the supplied DC power supply to feed power to the machine.
- ☒ Please use recommended interconnection cables to connect the machine to other components.  
\* FCC and CE approved using STP cable (for twisted pair products)



---

For the latest information on our products and a list of Kramer distributors, visit our Web site [www.kramerelectronics.com](http://www.kramerelectronics.com) where updates to this user manual may be found. We welcome your questions, comments, and feedback.



Caution

**Safety Warning:**

Disconnect the unit from the power supply before opening/servicing.



---

**Kramer Electronics, Ltd.**

Web site: [www.kramerelectronics.com](http://www.kramerelectronics.com)

E-mail: [info@kramerel.com](mailto:info@kramerel.com)

P/N: 2900-000607 REV 2