

Kramer Electronics, Ltd.

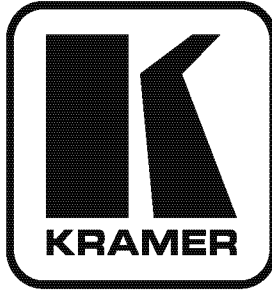

USER MANUAL

Models:

PT-110-od and TP-120-od XGA Line Transmitter, Receiver

TP-121-od and TP-122-od XGA/Audio Line Transmitter, Receiver

TP-123-od and TP-124-od XGA/Audio/Data Line Transmitter, Receiver

TP-125-od and TP-126-od XGA/Audio/Data Line Transmitter, Receiver

Contents

1	Introduction	1
2	Getting Started	1
2.1	Quick Start	2
3	Overview	3
3.1	Shielded Twisted Pair (STP) / Unshielded Twisted Pair (UTP)	3
3.2	About the Power Connect Feature	4
3.3	Defining EDID	4
3.4	Recommendations for Achieving the Best Performance	4
4	The PT-110-od / TP-120-od Transmitter / Receiver Set	5
4.1	Your PT-110-od XGA / Line Transmitter	6
4.2	Your TP-120-od XGA Line Receiver	7
4.3	Connecting the PT-110-od / TP-120-od Transmitter / Receiver	8
4.4	Technical Specifications of the PT-110-od and the TP-120-od	10
5	The TP-121-od / TP-122-od Transmitter / Receiver Set	11
5.1	Your TP-121-od XGA / Audio Line Transmitter	12
5.2	Your TP-122-od XGA / Audio Line Receiver	13
5.3	Connecting the TP-121-od / TP-122-od Transmitter / Receiver	14
5.4	Technical Specifications of the TP-121-od and the TP-122-od	16
6	The TP-123-od / TP-124-od Transmitter / Receiver Set	17
6.1	Your TP-123-od XGA / Audio / Data Line Transmitter	18
6.2	Your TP-124-od XGA / Audio Line Receiver	19
6.3	Connecting the XGA / Audio / Data Line Transmitter / Receiver	20
6.4	Controlling via RS-232 (for example, using a PC)	22
6.5	Technical Specifications of the TP-123-od and the TP-124-od	23
7	The TP-125-od / TP-126-od Transmitter / Receiver Set	24
7.1	Your TP-125-od XGA / Audio / Data Line Transmitter	25
7.2	Your TP-126-od XGA / Audio / Data Line Receiver	26
7.3	Connecting the TP-125-od and TP-126-od	27
7.4	Transmitting via RS-232 (for example, using a PC)	29
7.5	Technical Specifications	30
8	Wiring the CAT 5 LINE IN / LINE OUT RJ-45 Connectors	31
9	Acquiring the EDID	31

Figures

Figure 1: PT-110-od XGA Line Transmitter	6
Figure 2: TP-120-od XGA Line Receiver	7
Figure 3: Connecting the PT-110-od to the TP-120-od	9
Figure 4: TP-121-od XGA / Audio Line Transmitter	12
Figure 5: TP-122-od XGA / Audio Line Receiver (Topside)	13
Figure 6: Connecting the TP-121-od and the TP-122-od	15
Figure 7: TP-123-od XGA / Audio / Data Line Transmitter	18
Figure 8: TP-124-od XGA / Audio / Data Line Receiver (Topside)	19
Figure 9: Connecting the TP-123-od and the TP-124-od	21
Figure 10: RS-232 PINOUT Connection	22
Figure 11: TP-125-od XGA / Audio / Data Line Transmitter	25
Figure 12: TP-126-od XGA / Audio / Data Line Receiver	26
Figure 13: Connecting the TP-125-od and the TP-126-od	28
Figure 14: RS-232 PINOUT Connection	29
Figure 15: CAT 5 PINOUT	31

Tables

Table 1: PT-110-od XGA Line Transmitter Features	6
Table 2: TP-120-od XGA Line Receiver Features	7
Table 3: Technical Specifications of the PT-110-od and the TP-120-od	10
Table 4: TP-121-od XGA / Audio Line Transmitter Features	12
Table 5: TP-122-od XGA / Audio Line Receiver (Topside) Features	13
Table 6: Technical Specifications of the TP-121-od and the TP-122-od	16
Table 7: TP-123-od XGA / Audio / Data Line Transmitter Features	18
Table 8: TP-124-od XGA / Audio / Data Line Receiver (Topside) Features	19
Table 9: RS-232 PINOUT Connection	22
Table 10: Technical Specifications of the TP-123-od and the TP-124-od	23
Table 11: TP-125-od XGA / Audio / Data Line Transmitter Features	25
Table 12: TP-126-od XGA / Audio / Data Line Receiver Features	26
Table 13: RS-232 PINOUT Connection	29
Table 14: Technical Specifications of the TP-125-od and the TP-126-od	30
Table 15: CAT 5 PINOUT	31

1 Introduction

Welcome to Kramer Electronics! Since 1981, Kramer Electronics has been providing a world of unique, creative, and affordable solutions to the vast range of problems that confront the video, audio, presentation, and broadcasting professional on a daily basis. In recent years, we have redesigned and upgraded most of our line, making the best even better! Our 1,000-plus different models now appear in 11 groups¹ that are clearly defined by function.

Thank you for purchasing your Kramer transmitter and receiver set that includes special protection against EMP². The “od³ series” sets that are available include the:

- **PT-110-od XGA Line Transmitter** and **TP-120-od XGA Line Receiver**
- **TP-121-od XGA / Audio Line Transmitter** and **TP-122-od XGA / Audio Line Receiver**
- **TP-123-od XGA / Audio / Data Line Transmitter** and **TP-124-od XGA / Audio / Data Line Receiver**
- **TP-125-od XGA / Audio / Data Line Transmitter** and **TP-126-od XGA / Audio / Data Line Receiver**

Each “od series” set is ideal for presentation and multimedia applications. The package includes:

- One or more of the following: **PT-110-od**, **TP-120-od**, **TP-121-od**, **TP-122-od**, **TP-123-od**, **TP-124-od**, **TP-125-od** or **TP-126-od**
- Power adapter (12V DC) and this user manual⁴

2 Getting Started

We recommend that you:

- Unpack the equipment carefully and save the original box and packaging materials for possible future shipment
- Review the contents of this user manual
- Use Kramer high-performance high-resolution cables⁵

1 GROUP 1: Distribution Amplifiers; GROUP 2: Switchers and Matrix Switchers; GROUP 3: Control Systems; GROUP 4: Format/Standards Converters; GROUP 5: Range Extenders and Repeaters; GROUP 6: Specialty AV Products; GROUP 7: Scan Converters and Sealers; GROUP 8: Cables and Connectors; GROUP 9: Room Connectivity; GROUP 10: Accessories and Rack Adapters; GROUP 11: Sierra Products

2 Electromagnetic Pulse

3 Overvoltage Defense

4 Download up-to-date Kramer user manuals at <http://www.kramerelectronics.com>

5 The complete list of Kramer cables is on our Web site at <http://www.kramerelectronics.com>

2.1 Quick Start

This quick start chart summarizes the basic setup and operation steps.

To connect your Kramer Transmitter/Receiver

- 1 Connect the sources to the Input connectors and the outputs to the acceptors.
- 2 Connect the LINE OUTPUT RJ-45 connector on the transmitter to the LINE IN RJ-45 connector on the appropriate receiver.
- 3 Connect the power to both the transmitter and the appropriate receiver (unless the Power Connect™ system applies).

Source → **Transmitter** — CAT 5 — **Receiver** → Acceptor

For each transmitter/receiver pair connect the following:

VGA →	<p style="font-size: small; text-align: center;">VGA Line Transmitter TP-115-od</p>	CAT 5	<p style="font-size: small; text-align: center;">XGA Line Receiver TP-116-od</p>	→ VGA
VGA → Audio →	<p style="font-size: small; text-align: center;">XGA / Audio Line Transmitter TP-121-od</p>	CAT 5	<p style="font-size: small; text-align: center;">XGA / Audio Line Receiver TP-122-od</p>	→ VGA → Audio
VGA → Audio → 2-pin RS-232	<p style="font-size: small; text-align: center;">XGA / Audio / Data Line Transmitter TP-123-od</p>	CAT 5	<p style="font-size: small; text-align: center;">XGA / Audio / Data Line Receiver TP-124-od</p>	→ VGA → Audio → 2-pin → RS-232
VGA → Audio → 3-pin RS-232	<p style="font-size: small; text-align: center;">XGA / Audio / Data Line Transmitter TP-125-od</p>	CAT 5	<p style="font-size: small; text-align: center;">LXGA / Audio / Data Line Receiver TP-126-od</p>	→ VGA → Audio → 3-pin → RS-232

To acquire the EDID

1. Connect the XGA INPUT 15-pin HD connector to the input XGA connector of the display, using a short cable.
2. Connect the display power.
3. On the Transmitter, connect the 12V DC power adapter to the power socket and connect the adapter to the mains electricity.
4. Press the EDID CAPTURE button.
5. Once the EDID STATUS blinks slowly several times, the EDID is captured.
6. Disconnect the display.

3 Overview

Kramer's new "od" (Overvoltage Defense) family of twisted pair transmitters and receivers for computer graphics video now includes electromagnetic pulse (EMP) protection. The electro-magnetic pulse of nearby lightning strikes can damage sensitive electronic equipment by inducing high momentary surge voltages. Systems with outdoor runs of signal cable are very susceptible to EMP damage. Our "od" family was especially designed to protect twisted pair transmitter/receiver systems installed in areas of high electrical storm activity.

Note, that the "od" family is designed for indoor installation and should be suitably protected against direct lightning strikes. The system does not protect against direct lightning strikes and does not offer protection against damage caused by lightning to peripheral devices that are connected to an "od series" transmitter/receiver set.

This user manual describes the following lightning protected transmitter receiver sets:

- **PT-110-od / TP-120-od** XGA Line Transmitter / Receiver (see section [4](#))
- **TP-121-od / TP-122-od** XGA / Audio Line Transmitter / Receiver (see section [5](#))
- **TP-123-od / TP-124-od** XGA / Audio / Data Line Transmitter / Receiver (see section [6](#))
- **TP-125-od / TP-126-od** XGA / Audio / Data Line Transmitter / Receiver (see section [7](#))

This section describes:

- Using shielded twisted pair (STP) / unshielded twisted pair (UTP), see section [3.1](#)
- The power connect feature, see section [3.2](#)
- Defining EDID, see section [3.3](#)
- Recommendations for achieving the best performance, see section [3.4](#)

3.1 Shielded Twisted Pair (STP) / Unshielded Twisted Pair (UTP)

We recommend that you use shielded twisted pair (STP) cable. There are different levels of STP cable available, and we advise you to use the best quality STP cable that you can afford. Our non-skew-free cable, Kramer **BC-STP** is intended for analog signals where skewing is not an issue. For cases where there is skewing, our UTP skew-free cable, Kramer **BC-XTP**, may be used. Bear in mind, though, that we advise using STP cables where possible, since the compliance to electromagnetic interference was tested using those cables.

Although unshielded twisted pair (UTP) cable might be preferred for long range applications, the UTP cable should be installed far away from electric cables, motors and so on, which are prone to create electrical interference. However, since the use of UTP cable might cause inconformity to electromagnetic standards, Kramer does not commit to meeting the standard with UTP cable.

3.2 About the Power Connect Feature

The Power Connect feature¹ applies as long as the cable can carry power. The distance does not exceed 50m on standard CAT 5 cable, for longer distances, heavy gauge cable should be used².

For a CAT 5 cable exceeding a distance of 50m, separate power supplies should be connected to the transmitter and to the receiver simultaneously.

3.3 Defining EDID

The **PT-110-od**, **TP-121-od**, **TP-123-od**, and **TP-125-od** include:

- EDID Capture - Copies and stores the EDID from a display device

The Extended Display Identification Data (EDID³) is a data-structure, provided by a display, to describe its capabilities to a graphics card (that is connected to the display's source). The EDID enables the graphic source to "know" what kind of monitor is connected to the output. The EDID includes the manufacturer's name, the product type, the timing data supported by the display, the display size, luminance data and (for digital displays only) the pixel mapping data.

3.4 Recommendations for Achieving the Best Performance

To achieve the best performance:

- Use only good quality connection cables⁴ to avoid interference, deterioration in signal quality due to poor matching, and elevated noise levels (often associated with low quality cables).
- Avoid interference from neighboring electrical appliances that may adversely influence signal quality and position your Kramer transmitters away from moisture, excessive sunlight and dust

1 The power connect feature does not apply to the TP-125-od and TP-126-od

2 CAT 5 cable is still suitable for the video/audio transmission, but not for feeding the power at these distances

3 Defined by a standard published by the Video Electronics Standards Association (VESA)

4 Available from Kramer Electronics on our Web site at <http://www.kramerelectronics.com>

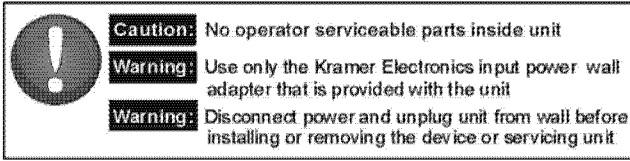

4 The PT-110-od / TP-120-od Transmitter / Receiver Set

The Kramer Pico TOOLS **PT-110-od** is an XGA line transmitter that receives an XGA signal (up to UXGA), converts it to a twisted pair signal, and transmits it over a CAT 5 cable to the Kramer TOOLS **TP-120-od** receiver which converts it back to an XGA signal. Together the **PT-110-od** and **TP-120-od** form a computer graphics transmitter/receiver system.

The transmitter receiver system has an operating range of more than 300ft (more than 100m) using standard CAT 5 cable, has the Power Connect feature¹ and is 12V DC fed.

The **PT-110-od** is pre-programmed with default EDID settings with EDID information ready for the source even before capturing the EDID from the display. When the **PT-110-od** is connected to a display device and the EDID CAPTURE button is pressed, the **PT-110-od** reads and stores the EDID (Extended Display Identification Data) from the display device. The display can be disconnected and later reconnected without rebooting the operating system.

The **TP-120-od** includes EQ. and LEVEL controls.

¹ Powering via the CAT 5 cable from either the receiver or the transmitter is good for 50 meters. Above it, both sides should be fed with power

4.1 Your PT-110-od XGA / Line Transmitter

Figure 1 and Table 1 define the **PT-110-od**:

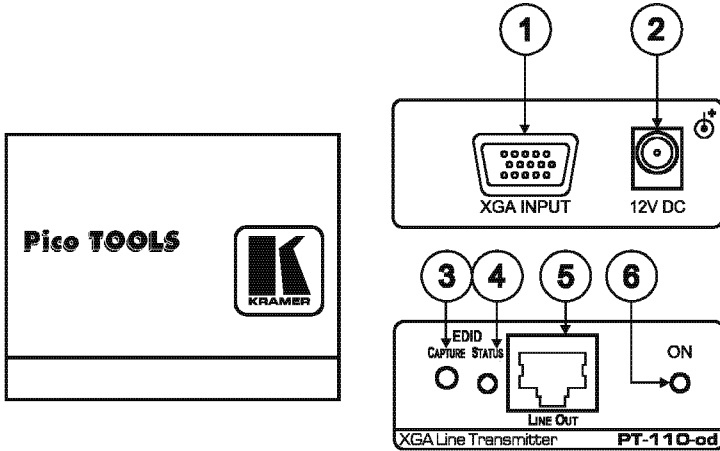

Figure 1: PT-110-od XGA Line Transmitter

Table 1: PT-110-od XGA Line Transmitter Features

#	Feature	Function	
1	XGA IN 15-pin HD (F) Connector	Connect to the UXGA source	
2	12V DC	+12V DC connector for powering the unit	
3	EDID ¹	CAPTURE Button	Press to acquire the EDID information from the display
4		STATUS LED	Illuminates during normal operation; blinks when acquiring the EDID
5	LINE OUT RJ-45 Connector	Connects to the LINE IN RJ-45 connector on the TP-120-od (see section 8)	
6	ON LED	Illuminates when receiving power	

¹ See section 2

4.2 Your TP-120-od XGA Line Receiver

Figure 2 and Table 2 define the **TP-120-od XGA Line Receiver**:

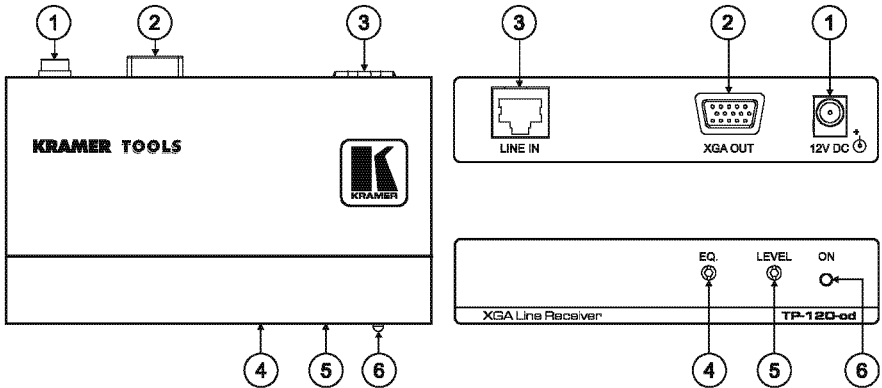

Figure 2: TP-120-od XGA Line Receiver

Table 2: TP-120-od XGA Line Receiver Features

#	Feature	Function
1	12V DC	+12V DC connector for powering the unit
2	XGA OUT 15-pin HD (F) Connector	Connect to the XGA acceptor
3	LINE IN RJ-45 Connector	Connects to the LINE OUT RJ-45 connector on the PT-110-od (see section 8)
4	EQ. ¹ Trimmer	Adjusts ² the cable compensation equalization level
5	LEVEL Trimmer	Adjusts ² the output signal level
6	ON LED	Illuminates when receiving power

¹ Degradation and VGA/XGA signal loss can result from using long cables (due to stray capacitance), sometimes leading to a total loss of sharpness in high-resolution signals

² Use a screwdriver to carefully rotate the trimmer, adjusting the appropriate level

4.3 Connecting the PT-110-od / TP-120-od Transmitter / Receiver

You can use the **PT-110-od** *XGA Line Transmitter* together with the **TP-120-od** *XGA Line Receiver* to configure an XGA-to-Twisted Pair Transmitter and Receiver system.

Before connecting the transmitter and receiver system you can acquire the EDID (via **PT-110-od**) from the display or set the system to the default EDID, see section [9](#)

To connect the **PT-110-od** *XGA Line Transmitter* with the **TP-120-od** *XGA Line Receiver*, as the example in [Figure 3](#) illustrates, do the following:

1. On the **PT-110-od**, connect the XGA source (for example, the 15-pin HD output from a computer's graphics card) to the XGA INPUT 15-pin HD (F) connector.
2. On the **TP-120-od**, connect the XGA OUT 15-pin HD (F) connector to the XGA acceptor (for example, a display).
3. Connect the LINE OUTPUT RJ-45 connector on the **PT-110-od** to the LINE IN RJ-45 connector on the **TP-120-od**, via CAT 5 cabling (with a range of more than 300ft (>100m)), see section [8](#).
4. On both¹ the **PT-110-od** and the **TP-120-od**, connect the 12V DC power adapter to the power socket and connect the adapter to the mains electricity.

The signal from the XGA source is transmitted via CAT 5 cable, decoded and converted at the XGA OUT 15-pin HD (F) connector to the XGA acceptor.

5. If required, on the **TP-120-od**, adjust² the output signal level and/or cable compensation equalization level.

¹ For distances of up to 100 meters you can connect a power adapter to either the PT-110-od or TP-120-od. Above it, both sides should be fed with power

² Use a screwdriver to carefully rotate the trimmer, adjusting the appropriate level

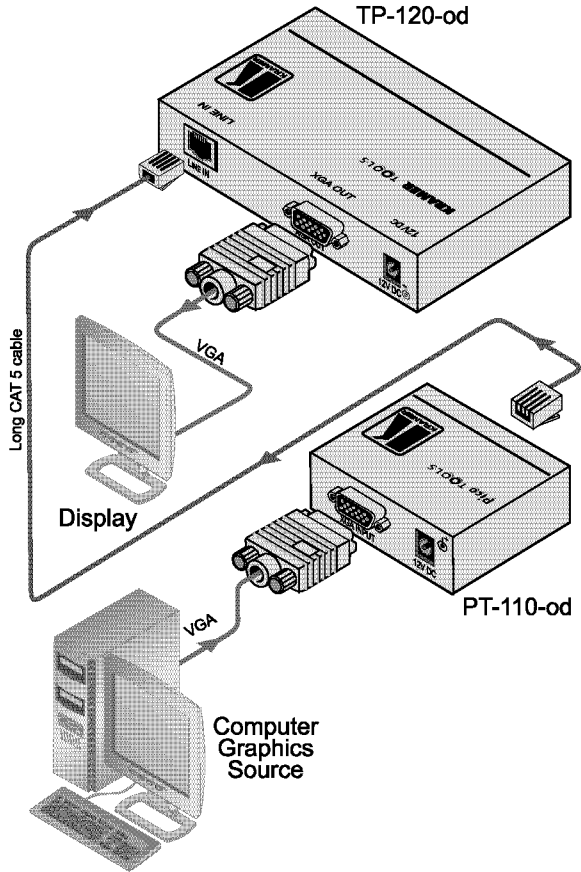

Figure 3: Connecting the PT-110-od to the TP-120-od

4.4 Technical Specifications of the PT-110-od and the TP-120-od

Table 3 includes the technical specifications¹ of the **PT-110-od** and the **TP-120-od**:

Table 3: Technical Specifications² of the PT-110-od and the TP-120-od

	PT-110-od	TP-120-od
INPUTS:	VIDEO: 1 VGA / UXGA on a 15-pin HD connector	1 RJ-45 connector
OUTPUTS:	1 RJ-45 connector	VIDEO: 1 VGA / UXGA on a 15-pin HD connector
MAX. OUTPUT LEVEL:	1.7Vpp	
BANDWIDTH:	150MHz	
RESOLUTION:	Up to UXGA	
DIFF. GAIN:	1.6%	
DIFF PHASE:	0.2 Deg.	
K-FACTOR:	<0.05%	
S/N RATIO:	70dB @5MHz	
CONTROLS:		LEVEL: -9dB to +2.5dB EQ.: 0dB to +31dB
COUPLING:		AC
POWER SOURCE:	12V DC 300mA	12V DC 240mA
DIMENSIONS:	12.1cm x 7.18cm x 2.42cm (4.76" x 2.83" x 0.95") W, D, H	
WEIGHT:	0.3kg (0.67lbs) approx.	
ACCESSORIES:	Power supply	
OPTIONS:	RK-4PT rack adapter	RK-3T rack adapter

¹ The measurements are presented for the transmitter/receiver pair

² Specifications are subject to change without notice

5 The TP-121-od / TP-122-od Transmitter / Receiver Set

The Kramer TOOLS **TP-121-od** is an XGA / audio stereo line transmitter. It receives an XGA signal and an unbalanced stereo analog audio signal¹ converts them to a twisted pair signal and transmits them over CAT 5 cable to the Kramer TOOLS **TP-122-od**.

The **TP-121-od**, with the **TP-122-od**, provides an operation range of more than 300ft (more than 100m) over standard CAT 5 cable, has the Power Connect feature² and is 12V DC fed.

The **TP-121-od**:

- Has a 20kHz audio bandwidth with an S/N ratio that exceeds 80dB on the same transmission range
- When connected to a display device and the EDID CAPTURE button is pressed, reads and stores the EDID (Extended Display Identification Data) from the display device. The display can be disconnected and later reconnected without rebooting the operating system

In addition, the **TP-122-od**:

- Includes EQ. and level controls

This section defines the **TP-121-od** *XGA / Audio Line Transmitter* (see section [5.1](#)), and the **TP-122-od** *XGA / Audio Line Receiver* (see section [5.2](#)).

1 The unbalanced stereo analog audio signal is converted to digital audio (S/PDIF) stream before transmitting, thus preserving the quality of the audio signal

2 Powering via the CAT 5 cable from either the receiver or the transmitter is good for 50 meters. Above it, both sides should be fed with power

5.1 Your TP-121-od XGA / Audio Line Transmitter

Figure 4 and Table 4 define the TP-121-od:

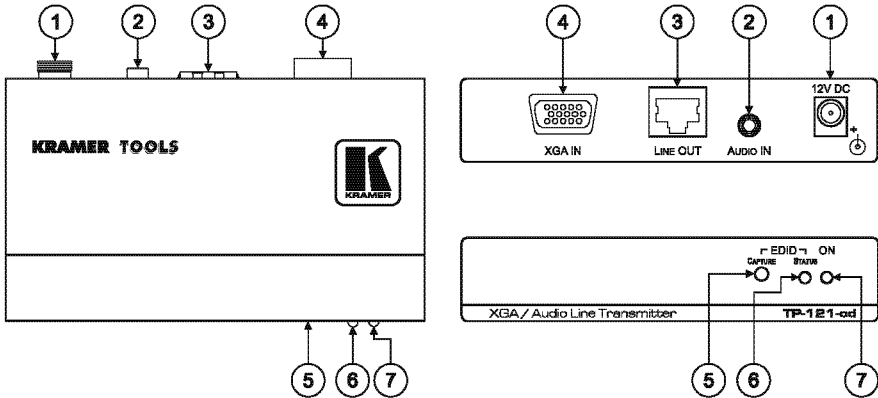

Figure 4: TP-121-od XGA / Audio Line Transmitter

Table 4: TP-121-od XGA / Audio Line Transmitter Features

#	Feature	Function	
1	12V DC	+12V DC connector for powering the unit	
2	AUDIO IN 3.5mm Mini Jack	Connects to the audio source	
3	LINE OUT RJ-45 Connector	Connects to the LINE IN RJ-45 connector on a receiver (see section 8)	
4	XGA IN 15-pin HD (F) Connector	Connect to the XGA source	
5	EDID ¹	CAPTURE Button	Press to acquire the EDID information from the display
6		STATUS LED	Illuminates during normal operation; blinks when acquiring the EDID
7	ON LED	Illuminates when receiving power	

¹ See section 9

5.2 Your TP-122-od XGA / Audio Line Receiver

Figure 5 and Table 5 define the TP-122-od XGA / Audio Line Receiver topside:

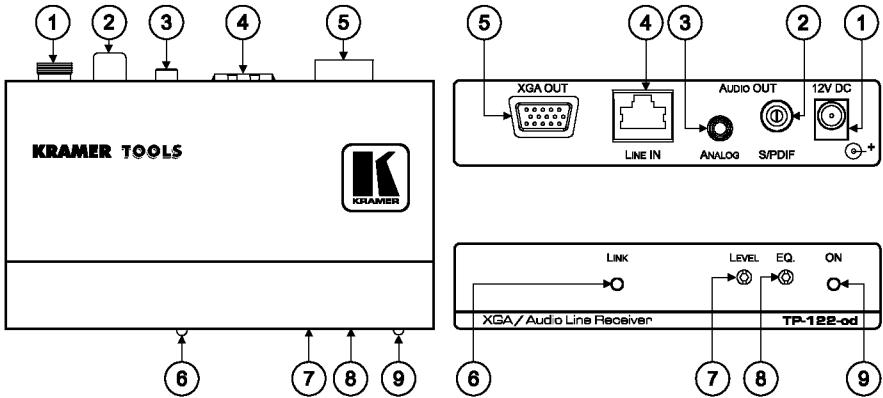

Figure 5: TP-122-od XGA / Audio Line Receiver (Topside)

Table 5: TP-122-od XGA / Audio Line Receiver (Topside) Features

#	Feature	Function
1	12V DC	+12V DC connector for powering the unit
2	AUDIO OUT	S/PDIF RCA Connector
3		Connects to the digital audio acceptor
		ANALOG 3.5mm Mini Jack
		Connects to the analog audio acceptor
4	LINE IN RJ-45 Connector	Connects to the TP-121-od (see section 3)
5	XGA OUT 15-pin HD (F) Connector	Connects to the XGA acceptor
6	LINK LED	Illuminates when receiving the correct input signal
7	LEVEL Trimmer	Adjusts ² the output signal level
8	EQ. ¹ Trimmer	Adjusts ² the cable compensation equalization level
9	ON LED	Illuminates when receiving power

¹ Degradation and VGA/XGA signal loss can result from using long cables (due to stray capacitance), sometimes leading to a total loss of sharpness in high-resolution signals

² Use a screwdriver to carefully rotate the trimmer, adjusting the appropriate level

5.3 Connecting the TP-121-od / TP-122-od Transmitter / Receiver

You can use the **TP-121-od** together with the **TP-122-od** to configure an XGA/Audio Line-to-Twisted Pair Transmitter and Receiver system.

Before connecting the transmitter and receiver system you can acquire the EDID (via **TP-121-od**) from the display or set the system to the default EDID, see section 9

To connect the **TP-121-od** XGA / Audio Line Transmitter with the **TP-122-od** XGA / Audio Line Receiver, as the example in Figure 6 illustrates, do the following:

1. On the **TP-121-od**, connect the XGA source (for example, a laptop's graphics card) to the XGA INPUT 15-pin HD (F) connector and an audio source to the AUDIO IN 3.5mm mini jack, for example, using a Kramer C-GMA/GMA cable (VGA 15-pin HD (M) +Audio jack to VGA 15-pin HD (M) +Audio jack)¹. Alternatively, you can connect an XGA source to the XGA INPUT 15-pin HD (F) connector, and a separate audio source to the AUDIO IN 3.5mm mini jack.
2. On the **TP-122-od**, connect the XGA OUT 15-pin HD (F) connector to the XGA acceptor (for example, a display), and connect the AUDIO OUT S/PDIF RCA connector to the digital audio acceptor (for example, an AV Receiver), and the ANALOG 3.5mm mini jack to the analog audio acceptor (for example, a stereo audio recorder).
3. Connect the LINE OUTPUT RJ-45 connector on the **TP-121-od** to the LINE IN RJ-45 connector on the **TP-122-od**, via CAT 5 cabling (with a range of more than 300ft (>100m)), see section 8.
4. Connect the 12V DC power adapter to the power socket and connect the adapter to the mains electricity on both² the **TP-121-od** and the **TP-122-od**. The signal from the XGA source is transmitted via CAT 5 cable, decoded and converted at the XGA OUT 15-pin HD (F) connector to the XGA acceptor.
5. If required, on the **TP-122-od** adjust³ the video output signal level and/or cable compensation equalization level.

1 Not supplied. The complete list of Kramer cables is on our Web site at <http://www.kramerelectronics.com>

2 If you cannot connect the power to both the TP-121-od and TP-122-od, you can just connect the power to the TP-122-od

3 Use a screwdriver to carefully rotate the trimmer, adjusting the appropriate level

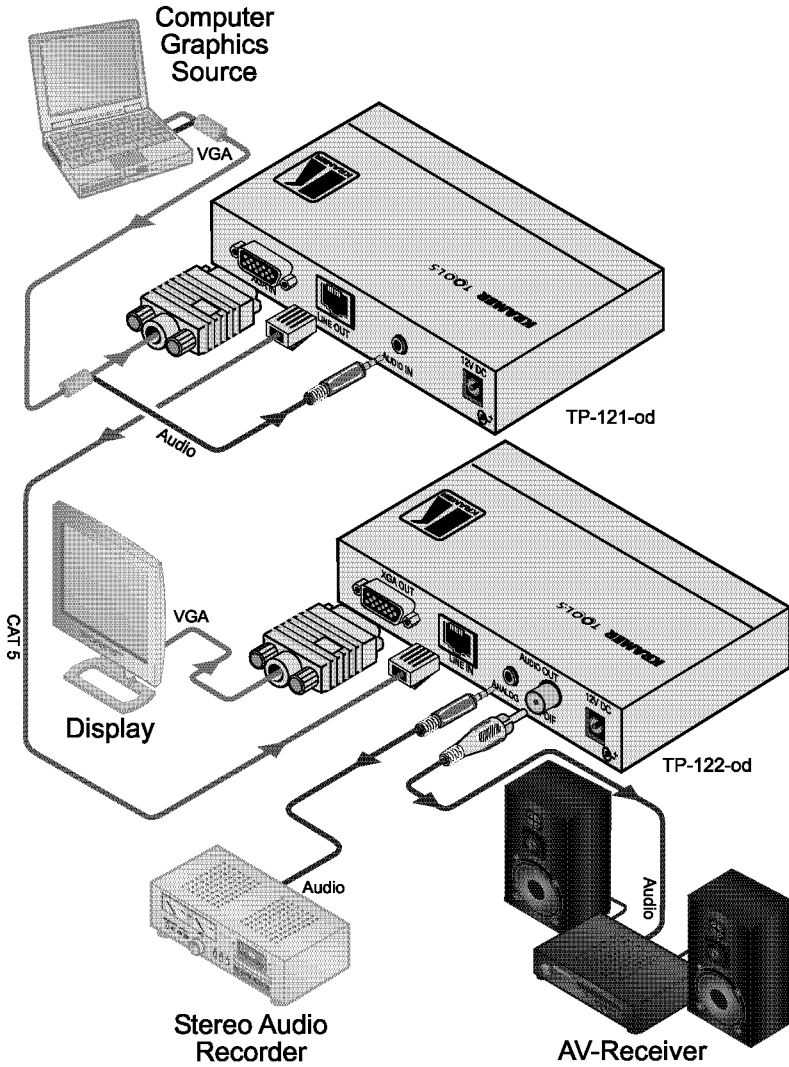

Figure 6: Connecting the TP-121-od and the TP-122-od

5.4 Technical Specifications of the TP-121-od and the TP-122-od

Table 6 includes the technical specifications¹ of the **TP-121-od** and the **TP-122-od**.

Table 6: Technical Specifications² of the TP-121-od and the TP-122-od

	TP-121-od	TP-122-od
INPUTS:	VIDEO: 1 VGA / UXGA on a 15-pin HD connector AUDIO: 1 analog unbalanced stereo audio on a 3.5mm mini jack	1 RJ-45 connector
OUTPUTS:	1 RJ-45 connector	VIDEO: 1 VGA / UXGA on a 15-pin HD connector AUDIO: 1 audio S/PDIF on an RCA connector 1 analog unbalanced stereo audio on a 3.5mm mini jack
MAX. OUTPUT LEVEL:	VIDEO: 1.8V; AUDIO: 2.9Vpp	
BANDWIDTH (-3dB):	AUDIO: 21kHz; VIDEO: 150MHz	
RESOLUTION:	Up to UXGA	
DIFF. GAIN:	1.8%	
DIFF. PHASE:	0.3 DEG.	
K-FACTOR:	<0.05%	
S/N RATIO:	VIDEO: 62dB @5MHz AUDIO: 69dB @1kHz	
CROSSTALK (all hostile):	VIDEO: -58dB, video into audio	
CONTROLS (VIDEO):		LEVEL, -8.5dB to 3.2dB EQ.: 0dB to 31.5dB
COUPLING:	VIDEO: AC AUDIO: AC	VIDEO: AC AUDIO: IN – AC, OUT – DC
AUDIO THD + NOISE:	0.2% @1kHz	
AUDIO 2 nd HARMONIC:	0.01% @1kHz	
POWER SOURCE:	12V DC 380mA	12V DC 350mA
DIMENSIONS:	12.1cm x 7.18cm x 2.42cm (4.76" x 2.83" x 0.95") W, D, H	
WEIGHT:	0.3kg (0.67lbs) approx.	
ACCESSORIES:	Power supply	
OPTIONS:	RK-3T rack adapter	

¹ The measurements are presented for the transmitter/receiver pair

² Specifications are subject to change without notice

6 The TP-123-od / TP-124-od Transmitter / Receiver Set

The **TP-123-od** is a high-performance transmitter. It accepts a computer graphics input signal, an unbalanced stereo analog audio signal¹, unidirectional (Rx/D) RS-232 control commands and 12V DC power, over CAT 5 cable, and transmits to the **TP-124-od**. The **TP-123-od** can power or be powered by the **TP-124-od** transmitter over the same CAT 5 cable and is 12V DC fed.

The **TP-124-od** outputs a computer graphics signal, an unbalanced stereo analog audio signal, a converted digital audio (S/PDIF) signal and RS-232 control commands. The unidirectional (Tx/D) RS-232 interface makes it possible to control virtually any devices over a transmission range of more than 300ft (more than 100m) over UTP cabling.

When the **TP-123-od** is connected to a display device and the EDID CAPTURE button is pressed, the **TP-123-od** reads and stores the EDID (Extended Display Identification Data) from the display device. The display can be disconnected and later reconnected without rebooting the operating system.

In addition, the **TP-124-od** features:

- Level and EQ. control for the XGA signals
- 24 bit 48kHz S/PDIF digital audio that supplies the highest quality audio

¹ The stereo analog audio signal is converted to the digital audio (S/PDIF) stream before transmitting, thus preserving the quality of the audio source signals

6.1 Your TP-123-od XGA / Audio / Data Line Transmitter

Figure 7 and Table 7 define the TP-123-od:

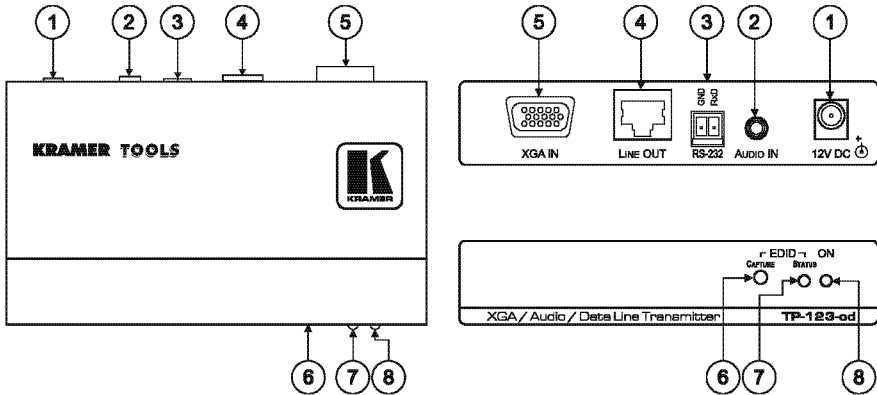

Figure 7: TP-123-od XGA / Audio / Data Line Transmitter

Table 7: TP-123-od XGA / Audio / Data Line Transmitter Features

#	Feature	Function
1	12V DC	+12V DC connector for powering the unit
2	AUDIO IN 3.5mm Mini Jack	Connects to the audio source
3	RS-232 Terminal Block Connector	Connects to the PC or the Remote Controller (see section 6.4)
4	LINE OUT RJ-45 Connector	Connects to ¹ the LINE IN RJ-45 connector on the TP-124-od XGA / Audio Line Receiver
5	XGA IN 15-pin HD (F) Connector	Connect to the XGA source
6	EDID ²	
	CAPTURE Button	Press to acquire the EDID information from the display
	STATUS LED	Illuminates during normal operation; blinks when acquiring the EDID
	ON LED	Illuminates when receiving power

¹ Using a CAT 5 cable with RJ-45 connectors at both ends (the PINOUT is defined in Table 15 and Figure 15)

² See section 9

6.2 Your TP-124-od XGA / Audio Line Receiver

Figure 8 and Table 8 define the TP-124-od XGA / Audio / Data Line Receiver:

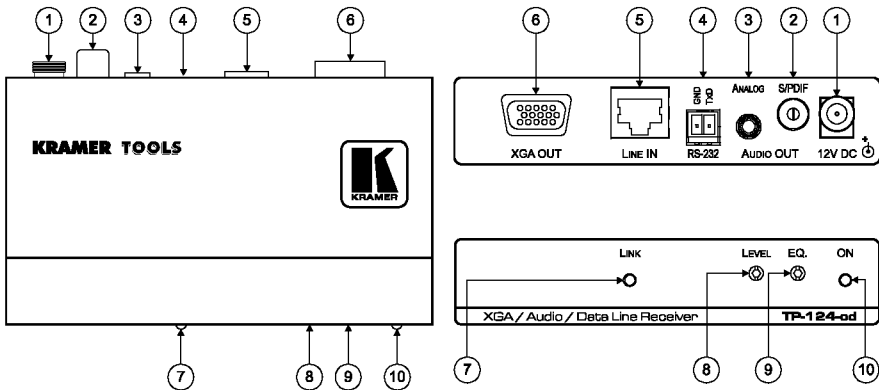

Figure 8: TP-124-od XGA / Audio / Data Line Receiver (Topside)

Table 8: TP-124-od XGA / Audio / Data Line Receiver (Topside) Features

#	Feature	Function
1	12V DC	+12V DC connector for powering the unit
2	AUDIO OUT	S/PDIF RCA Connector Connects to the digital audio acceptor
3		ANALOG 3.5mm Mini Jack Connects to the analog audio acceptor
4	RS-232 Terminal Block Connector	Connects to the controlled unit
5	LINE IN RJ-45 Connector	Connects to ¹ the LINE OUT RJ-45 connector on the TP-123-od
6	XGA OUT 15-pin HD (F) Connector	Connect to the XGA acceptor
7	LINK LED	Illuminates when receiving the correct input signal
8	LEVEL Trimmer	Adjusts ² the output signal level
9	EQ. ² Trimmer	Adjusts ³ the cable compensation equalization level
10	ON LED	Illuminates when receiving power

1 Using a UTP cable with CAT 5 connectors at both ends (the PINOUT is defined in Table 15 and Figure 15)

2 Degradation and VGA/XGA signal loss can result from using long cables (due to stray capacitance), sometimes leading to a total loss of sharpness in high-resolution signals

3 Use a screwdriver to carefully rotate the trimmer, adjusting the appropriate level

6.3 Connecting the XGA / Audio / Data Line Transmitter / Receiver

You can use the **TP-123-od** XGA / Audio / Data Line Transmitter together with the **TP-124-od** XGA / Audio / Data Line Receiver to configure a twisted pair transmitter and receiver system, to transmit the video, audio and RS-232 control signals via CAT 5 cable.

Before connecting the transmitter and receiver system you can acquire the EDID (via **TP-123-od**) from the display or set the system to the default EDID, see section [9](#)

To connect the **TP-123-od** and the **TP-124-od** to configure a twisted pair transmitter and receiver system, as the example in [Figure 9](#) illustrates, do the following:

1. On the **TP-123-od**, connect:
 - An XGA source (for example, a laptop's graphics card) to the XGA IN 15-pin HD (F) connector and an audio source to the Audio IN 3.5mm mini jack, for example, using a Kramer C-GMA/GMA cable (VGA 15-pin HD (M) +Audio jack to VGA 15-pin HD (M) +Audio jack)¹
 - An RS-232 cable with a 9-pin D-sub connector at one end to the laptop, and a 2-pin terminal block connector at the other end to the **TP-123-od** RS-232 port²
2. On the **TP-124-od**, connect:
 - The XGA OUT 15-pin HD (F) connector to a display
 - The S/PDIF Audio OUT RCA connector to a digital AV Receiver (leave the ANALOG Audio OUT 3.5mm mini jack unconnected)
 - An RS-232 cable with a 2-pin terminal block connector at one end to the **TP-124-od** RS-232 port², and a 9-pin D-sub connector at the other end to the RS-232 port on an RS-232 controllable device (for example, a switcher)
3. Connect the Line OUT RJ-45 connector on the **TP-123-od** to the LINE IN RJ-45 connector on the **TP-124-od**, via CAT 5 cabling (with a range of more than 300ft (>100m)), see section [8](#).

¹ Not supplied. The full list of Kramer cables is on our Web site at <http://www.kramerelectronics.com>. Alternatively, you can connect an XGA source to the XGA IN 15-pin HD (F) connector, and a separate audio source to the AUDIO IN 3.5mm mini jack

² As defined in section [6.4](#)

4. Connect the 12V DC power adapter to the power socket and connect the adapter to the mains electricity on both¹ the **TP-123-od** and the **TP-124-od**.
5. If required, on the **TP-124-od** adjust² the video output signal level and/or cable compensation equalization level.

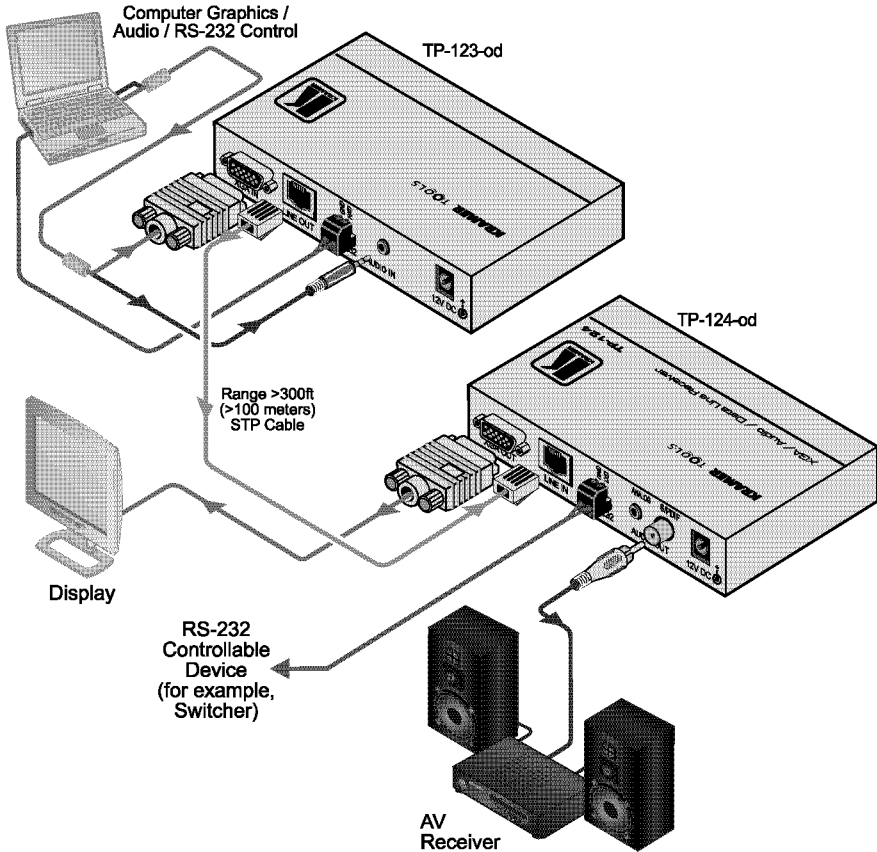

Figure 9: Connecting the TP-123-od and the TP-124-od

1 If you cannot connect the power to both the TP-123-od and TP-124-od, you can just connect the power to any one unit

2 Use a screwdriver to carefully rotate the trimmer, adjusting the appropriate level

6.4 Controlling via RS-232 (for example, using a PC)

Prepare an RS-232 cable with a 9-pin D-sub connector at one end, and a 2-pin terminal block connector at the other end, as defined in [Figure 10](#) and [Table 9](#):

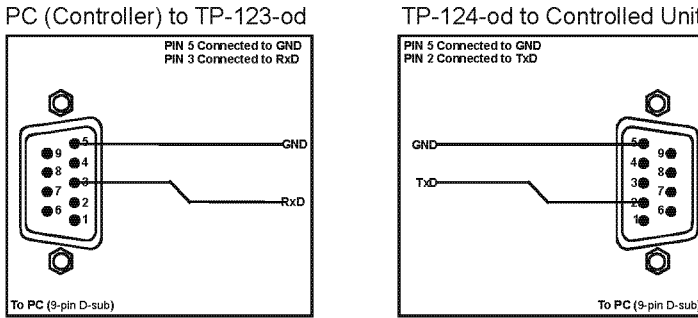

Figure 10: RS-232 PINOUT Connection

Table 9: RS-232 PINOUT Connection

Connect this PIN on the Terminal Block Connector:	To this PIN on the 9-pin D-sub Connector
TxD	PIN 2
RxD	PIN 3
GND	PIN 5

6.5 Technical Specifications of the TP-123-od and the TP-124-od

Table 10 includes the technical specifications¹ of the **TP-123-od** and the **TP-124-od**:

Table 10: Technical Specifications² of the TP-123-od and the TP-124-od

	TP-123-od	TP-124-od
INPUTS:	VIDEO: 1 VGA / UXGA on a 15-pin HD connector AUDIO: 1 analog unbalanced stereo audio on a 3.5mm mini jack	1 RJ-45 connector
OUTPUTS:	1 RJ-45 connector	VIDEO: 1 VGA / UXGA on a 15-pin HD connector AUDIO: 1 audio S/PDIF on an RCA connector 1 analog unbalanced stereo audio on a 3.5mm mini jack
MAX. OUTPUT LEVEL:	VIDEO: 1.8V; AUDIO: 2.9Vpp	
RS-232 BAUD RATE:	Up to 19200kbps	
BANDWIDTH (-3dB):	VIDEO: 150MHz; AUDIO: 19kHz	
RESOLUTION:	Up to UXGA	
DIFF. GAIN:	1.3%	
DIFF. PHASE:	0.2Deg.	
K-FACTOR	<0.1%	
S/N RATIO	VIDEO: 63dB @5MHz; AUDIO: 68dB @1kHz	
CROSSTALK (all hostile):	VIDEO: -56dB@50MHz into audio	
CONTROLS:	RS-232 on a 2-pin terminal block connector	RS-232 0n a 2-pin terminal block connector LEVEL: -9.5dB to 2.4dB, EQ.: 0dB to +32dBm
COUPLING:	VIDEO: AC AUDIO: AC	VIDEO: AC AUDIO: IN – AC, OUT - DC
AUDIO THD + NOISE:	0.2% @1kHz	
AUDIO 2 nd HARMONIC:	0.01% @1kHz	
POWER SOURCE:	12V DC 420mA	12V DC 320mA
DIMENSIONS:	12.1cm x 7.18cm x 2.42cm (4.76" x 2.83" x 0.95") W, D, H	
WEIGHT:	0.3kg (0.67lbs) approx.	
ACCESSORIES:	Power supply	
OPTIONS:	RK-3T rack adapter	

¹ The measurements are presented for the transmitter/receiver pair

² Specifications are subject to change without notice

7 The TP-125-od / TP-126-od Transmitter / Receiver Set

The Kramer TOOLS **TP-125-od** is a high-performance transmitter that accepts a computer graphics input signal, an unbalanced stereo analog audio signal and RS-232 control commands. The stereo analog audio signal is converted to the digital audio (S/PDIF) stream before transmitting, thus preserving the quality of the audio source signals.

The **TP-125-od** codes the signals and transmits them over CAT 5 cable to the Kramer TOOLS **TP-126-od**. The **TP-126-od** outputs a computer graphics signal, an unbalanced stereo analog audio signal, a converted digital audio (S/PDIF) signal, and bidirectional RS-232 control commands and data, to and from the **TP-125-od**. The RS-232 interface makes it possible to control virtually any device over a transmission range of more than 300 feet (more than 100 meters) over UTP cabling. The commands and data can flow in both directions via the RS-232 interface, allowing status requests and control of the destination unit. The **TP-125-od** can power or be powered by the **TP-126-od** transmitter over the same CAT 5 cable and is 12V DC fed.

When the **TP-125-od** is connected to a display device and the EDID CAPTURE button is pressed, the **TP-125-od** reads and stores the EDID (Extended Display Identification Data) from the display device. The display can be disconnected and later reconnected without rebooting the operating system.

In addition, the **TP-126-od** features:

- Level and EQ. control for the UXGA signals
- 24 bit 48kHz S/PDIF digital audio that supplies the highest quality audio

7.1 Your TP-125-od XGA / Audio / Data Line Transmitter

Figure 11 and Table 11 define the TP-125-od:

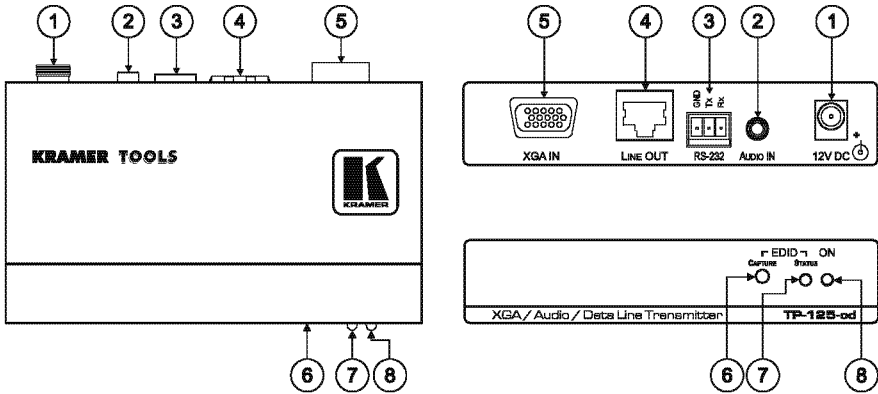

Figure 11: TP-125-od XGA / Audio / Data Line Transmitter

Table 11: TP-125-od XGA / Audio / Data Line Transmitter Features

#	Feature	Function	
1	12V DC	+12V DC connector for powering the unit	
2	AUDIO IN 3.5mm Mini Jack	Connects to the audio source	
3	RS-232 Terminal Block Connector	Connects to the PC or the Remote Controller (see section 7.4)	
4	LINE OUT RJ-45 Connector	Connects to the LINE IN RJ-45 connector on the TP-126-od UXGA / Audio Line Receiver	
5	UXGA IN 15-pin HD (F) Connector	Connect to the UXGA source	
6	EDID ¹	CAPTURE Button	Press to acquire the EDID information from the display
7		STATUS LED	Illuminates during normal operation; blinks when acquiring the EDID
8	ON LED	Illuminates when receiving power	

¹ See section 9

7.2 Your TP-126-od XGA / Audio / Data Line Receiver

Figure 12 and Table 12 define the TP-126-od:

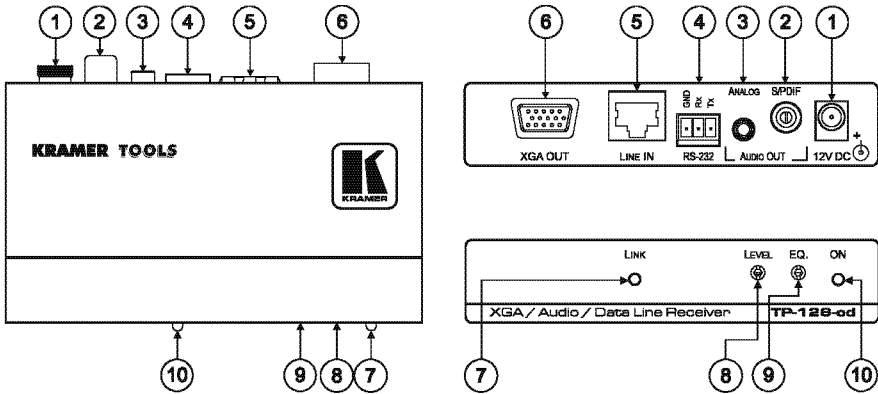

Figure 12: TP-126-od XGA / Audio / Data Line Receiver

Table 12: TP-126-od XGA / Audio / Data Line Receiver Features

#	Feature	Function
1	12V DC	+12V DC connector for powering the unit
2	AUDIO S/PDIF RCA connector	Connects to the digital audio acceptor
3	OUT ANALOG 3.5mm Mini Jack	Connects to the analog audio acceptor
4	RS-232 Terminal Block Connector	Connects to the controlled unit (see section 7.4)
5	LINE IN RJ-45 Connector	Connects to ¹ the LINE OUT RJ-45 connector on the TP-125-od
6	XGA OUT 15-pin HD (F) Connector	Connects to the UXGA acceptor
7	LINK LED	Illuminates when receiving the correct input signal
8	LEVEL Trimmer	Adjusts the output signal level
9	EQ. ² Trimmer	Adjusts the cable compensation equalization level
10	ON LED	Illuminates when receiving power

¹ Using a UTP cable with CAT 5 connectors at both ends (the PINOUT is defined in Figure 15 and Table 15)

² Degradation and UXGA signal loss can result from using long cables (due to stray capacitance), sometimes leading to a total loss of sharpness in high-resolution signals

7.3 Connecting the TP-125-od and TP-126-od

You can use the **TP-125-od XGA / Audio / Data Line Transmitter** together with the **TP-126-od XGA / Audio / Data Line Receiver**¹ to configure a twisted pair transmitter and receiver system, to transmit the video, audio and RS-232 control signals via CAT 5 cable.

Before connecting the transmitter and receiver system you can acquire the EDID (via **TP-125-od**) from the display or set the system to the default EDID, see section [9](#)

To connect the **TP-125-od** and the **TP-126-od** to create a twisted pair transmitter and receiver system, as the example in [Figure 13](#) illustrates, do the following:

1. On the **TP-125-od**, connect:
 - An UXGA source (for example, the graphics card on a laptop) to the UXGA IN 15-pin HD (F) connector and an audio source to the Audio IN 3.5mm mini jack, for example, using a Kramer C-GMA/GMA cable (VGA 15-pin HD (M) +Audio jack to VGA 15-pin HD (M) +Audio jack)²
 - An RS-232 cable with a 9-pin D-sub connector at one end to the laptop, and a 3-pin terminal block connector at the other end to the **TP-125-od** RS-232 port³
2. On the **TP-126-od**, connect:
 - The UXGA OUT 15-pin HD (F) connector to the AV display system
 - The S/PDIF Audio OUT RCA connector to a digital AV Receiver (leave the ANALOG Audio OUT 3.5mm mini jack unconnected)
 - An RS-232 cable with a 3-pin terminal block connector at one end to the **TP-126-od** RS-232 port², and a 9-PIN D-SUB connector at the other end to the RS-232 port on the AV display system
3. Connect the Line OUT RJ-45 connector on the **TP-125-od** to the LINE IN RJ-45 connector on the **TP-126-od**, via CAT 5 cabling⁴ (with a range of more than 300ft (>100m)).

1 Download up-to-date Kramer user manuals from our Web site at <http://www.kramerelectronics.com>

2 Not supplied. The full list of Kramer cables is on our Web site at <http://www.kramerelectronics.com>. Alternatively, you can connect an UXGA source to the UXGA IN 15-pin HD (F) connector, and a separate audio source to the AUDIO IN 3.5mm mini jack

3 As defined in [Figure 10](#) and [Table 9](#)

4 For details of how to wire a CAT 5 LINE IN / LINE OUT RJ-45 connector, see [Section 8](#)

4. Connect the 12V DC power supply to the power socket and connect the adapter to the mains electricity on both the **TP-125-od** and the **TP-126-od**.
5. If required, on the **TP-126-od** adjust the video output signal level and/or cable compensation equalization level with a screwdriver.

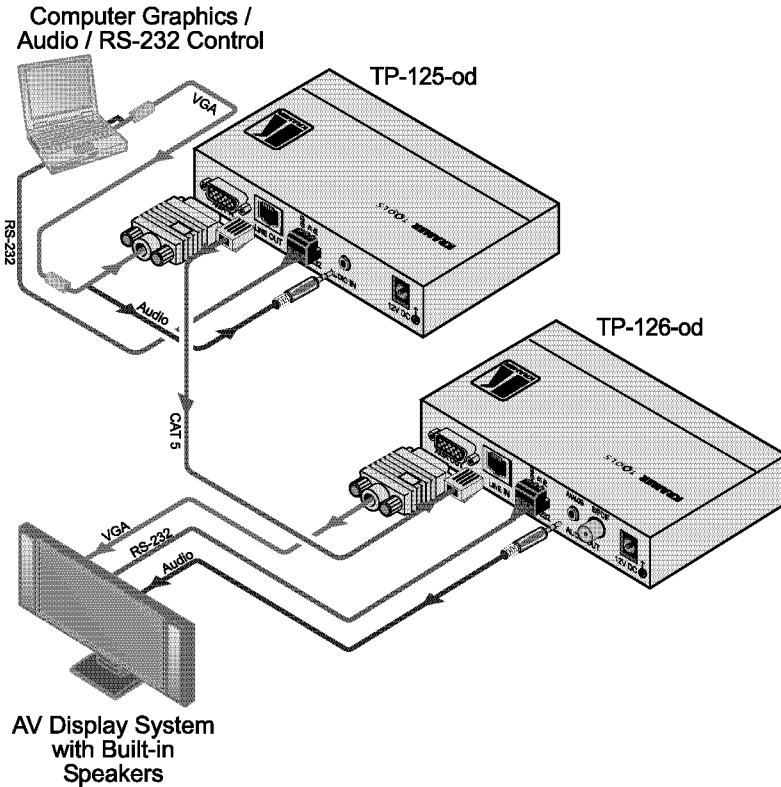

Figure 13: Connecting the TP-125-od and the TP-126-od

7.4 Transmitting via RS-232 (for example, using a PC)

Prepare an RS-232 cable with a 9-pin D-sub connector at one end, and a 3-pin terminal block connector at the other end, as defined in [Table 9](#) and [Figure 10](#):

Table 13: RS-232 PINOUT Connection

Connect this PIN on the Terminal Block Connector:	To this PIN on the 9-pin D-sub Connector:
TxD	PIN 2
RxD	PIN 3
GND	PIN 5

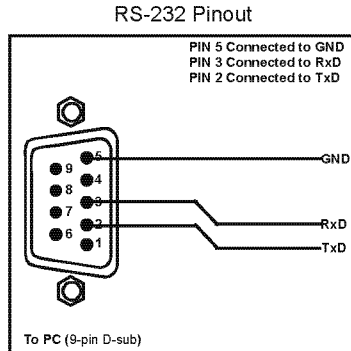

Figure 14: RS-232 PINOUT Connection

7.5 Technical Specifications

Table 14 includes the technical specifications¹ of the **TP-125-od** and the **TP-126-od**.

Table 14: Technical Specifications² of the TP-125-od³ and the TP-126-od

	TP-125-od	TP-126-od
INPUTS:	VIDEO: 1 UXGA on a 15-pin HD connector AUDIO: 1 analog unbalanced stereo audio on a 3.5mm mini jack	1 RJ-45 connector
OUTPUTS:	1 RJ-45 connector	VIDEO: 1 UXGA on a 15-pin HD connector AUDIO: 1 digital audio S/PDIF on an RCA connector 1 analog unbalanced stereo audio on a 3.5mm mini jack
MAX. OUTPUT LEVEL ⁴ :	VIDEO: 1.3Vpp; AUDIO: 3Vpp	
RS-232 BAUD RATE:	Up to 19200kbps	
BANDWIDTH (-3dB):	VIDEO: 150MHz; AUDIO: 22kHz	
RESOLUTION:	Up to UXGA	
DIFF. GAIN:	3.5%	
K-FACTOR	0.1%	
S/N RATIO	VIDEO: 60dB; AUDIO: 69dB	
CROSSTALK (all hostile):	VIDEO: -43dB @50MHz	
CONTROLS:	RS-232 on a 3-pin Terminal Block Connector	RS-232 on a 3-pin Terminal Block Connector LEVEL: -9.5dB to 2dB, EQ.: 0dB to +31dBm
COUPLING:	VIDEO: AC AUDIO: AC	VIDEO: AC AUDIO: IN – AC, OUT - DC
AUDIO THD + NOISE:	0.2% @1kHz	0.25% @1kHz
AUDIO 2 nd HARMONIC:	0.01% @1kHz	
POWER SOURCE:	12V DC 140mA	12V DC 210mA
DIMENSIONS:	12.1cm x 7.18cm x 2.42cm (4.76" x 2.83" x 0.95") W, D, H	
WEIGHT:	0.3kg (0.67lbs) approx.	
ACCESSORIES:	Power supply	
OPTIONS:	RK-3T rack adapter	

1 The measurements are presented for the transmitter/receiver pair

2 Specifications are subject to change without notice

3 With 60m CAT 5 cable

4 At the receiver output

8 Wiring the CAT 5 LINE IN / LINE OUT RJ-45 Connectors

Table 15 and Figure 15 define the UTP CAT 5 PINOUT, using a straight pin to pin cable with RJ-45 connectors:

Table 15: CAT 5 PINOUT

EIA /TIA 568A	
PIN	Wire Color
1	Green / White
2	Green
3	Orange / White
4	Blue
5	Blue / White
6	Orange
7	Brown / White
8	Brown
Pair 1 4 and 5	
Pair 2 3 and 6	
Pair 3 1 and 2	
Pair 4 7 and 8	

Figure 15: CAT 5 PINOUT

EIA /TIA 568B	
PIN	Wire Color
1	Orange / White
2	Orange
3	Green / White
4	Blue
5	Blue / White
6	Green
7	Brown / White
8	Brown
Pair 1 4 and 5	
Pair 2 1 and 2	
Pair 3 3 and 6	
Pair 4 7 and 8	

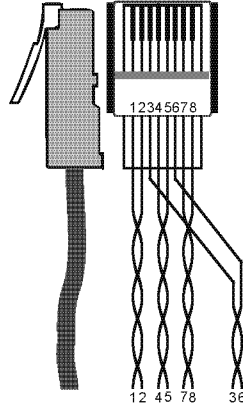

9 Acquiring the EDID

The transmitter can acquire the EDID information from the display connected to the transmitter or acquire the default EDID¹.

To acquire the display EDID, do the following:

1. Connect the XGA INPUT 15-pin HD connector to the input XGA connector of the display, using a short cable².
2. Connect the display power.
3. On the Transmitter, connect the 12V DC power adapter to the power socket and connect the adapter to the mains electricity.
4. Press the EDID CAPTURE button.
5. Once the EDID STATUS blinks slowly several times, the EDID is captured.
6. Disconnect the display.

To acquire the default EDID³:

¹ This section applies to the PT-110-od, TP-121-od, TP-123-od and TP-125-od)

² The EDID is carried over pins 12 and 15 of the VGA connector. It is essential that the cable used for capturing the EDID passes all 15 pins

³ Do not connect the display to the transmitter when acquiring the default EDID

1. On the Transmitter, connect the 12V DC power adapter to the power socket and connect the adapter to the mains electricity.
2. Press the EDID CAPTURE button.
3. Once the EDID STATUS blinks rapidly several times, the default EDID is captured.

Alternatively, you can press the EDID CAPTURE button after connecting the transmitter receiver system. When the EDID STATUS LED blinks rapidly several times, the default EDID information is acquired.

LIMITED WARRANTY

Kramer Electronics (hereafter *Kramer*) warrants this product free from defects in material and workmanship under the following terms.

HOW LONG IS THE WARRANTY

Labor and parts are warranted for seven years from the date of the first customer purchase.

WHO IS PROTECTED?

Only the first purchase customer may enforce this warranty.

WHAT IS COVERED AND WHAT IS NOT COVERED

Except as below, this warranty covers all defects in material or workmanship in this product. The following are not covered by the warranty:

1. Any product which is not distributed by Kramer, or which is not purchased from an authorized Kramer dealer. If you are uncertain as to whether a dealer is authorized, please contact Kramer at one of the agents listed in the Web site www.kramerelectronics.com.
2. Any product, on which the serial number has been defaced, modified or removed, or on which the WARRANTY VOID IF TAMPERED sticker has been torn, reattached, removed or otherwise interfered with.
3. Damage, deterioration or malfunction resulting from:
 - i) Accident, misuse, abuse, neglect, fire, water, lightning or other acts of nature
 - ii) Product modification, or failure to follow instructions supplied with the product
 - iii) Repair or attempted repair by anyone not authorized by Kramer
 - iv) Any shipment of the product (claims must be presented to the carrier)
 - v) Removal or installation of the product
 - vi) Any other cause, which does not relate to a product defect
 - vii) Cartons, equipment enclosures, cables or accessories used in conjunction with the product

WHAT WE WILL PAY FOR AND WHAT WE WILL NOT PAY FOR

We will pay labor and material expenses for covered items. We will not pay for the following:

1. Removal or installations charges.
2. Costs of initial technical adjustments (set-up), including adjustment of user controls or programming. These costs are the responsibility of the Kramer dealer from whom the product was purchased.
3. Shipping charges.

HOW YOU CAN GET WARRANTY SERVICE

1. To obtain service on you product, you must take or ship it prepaid to any authorized Kramer service center.
2. Whenever warranty service is required, the original dated invoice (or a copy) must be presented as proof of warranty coverage, and should be included in any shipment of the product. Please also include in any mailing a contact name, company, address, and a description of the problem(s).
3. For the name of the nearest Kramer authorized service center, consult your authorized dealer.

LIMITATION OF IMPLIED WARRANTIES

All implied warranties, including warranties of merchantability and fitness for a particular purpose, are limited in duration to the length of this warranty.

EXCLUSION OF DAMAGES

The liability of Kramer for any effective products is limited to the repair or replacement of the product at our option. Kramer shall not be liable for:

1. Damage to other property caused by defects in this product, damages based upon inconvenience, loss of use of the product, loss of time, commercial loss; or
2. Any other damages, whether incidental, consequential or otherwise. Some countries may not allow limitations on how long an implied warranty lasts and/or do not allow the exclusion or limitation of incidental or consequential damages, so the above limitations and exclusions may not apply to you.

This warranty gives you specific legal rights, and you may also have other rights, which vary from place to place.

NOTE: All products returned to Kramer for service must have prior approval. This may be obtained from your dealer.

This equipment has been tested to determine compliance with the requirements of:

- EN-50081: "Electromagnetic compatibility (EMC);
generic emission standard.
Part 1: Residential, commercial and light industry"
- EN-50082: "Electromagnetic compatibility (EMC) generic immunity standard.
Part 1: Residential, commercial and light industry environment".
- CFR-47:
FCC* Rules and Regulations:
Part 15: "Radio frequency devices
Subpart B Unintentional radiators"

CAUTION!

- ☒ Servicing the machines can only be done by an authorized Kramer technician. Any user who makes changes or modifications to the unit without the expressed approval of the manufacturer will void user authority to operate the equipment.
- ☒ Use the supplied DC power supply to feed power to the machine.
- ☒ Please use recommended interconnection cables to connect the machine to other components.
* FCC and CE approved using STP cable (for twisted pair products)



For the latest information on our products and a list of Kramer distributors, visit our Web site: www.kramerelectronics.com, where updates to this user manual may be found. We welcome your questions, comments and feedback.



Caution

Safety Warning:

Disconnect the unit from the power supply before opening/servicing.



Kramer Electronics, Ltd.

Web site: www.kramerelectronics.com

E-mail: info@kramerel.com

P/N: 2900-000637 REV 3